

DN74 User Manual



Statement

The copyright of this manual belongs to Shenzhen JEHE Technology Development Co., Ltd. (Giada, JEHE's global brand) and all rights are reserved. The company reserves the right to change this manual at any time without notification. Specifications here are for reference only, please take the real product as standard.

Without official authorization of Giada, other company or individual may not copy, plagiarize, translate or disseminate this manual for commercial purpose.

The information provided in this manual is accurate and reliable. The company does not take any legal responsibility for the consequences of infringement use of this manual.

Safety Notice

- Read the user manual carefully before setting up the Giada product.
- Disconnect the power cord before installing the internal components
- Most electronic components are sensitive to static electrical charge, please wear a wrist-grounding strap when installing the internal components.
- Don't disconnect the power cord when the system is running to avoid damage to the sensitive components by instantaneous surge voltage.

Contact Information

Shenzhen JEHE Technology Development Co., Ltd.

Website: www.giadatech.com

Phone: +86-755-3330 0336

Email: support@giadatech.com

Address: 1~3/F, Block A, Tsinghua Information Harbor, North Section, Shenzhen Hi-tech Park, Nanshan District, Shenzhen, China

Table of Contents

1. Product Introduction	3
2. Interface Description and Hardware Specifications	3
2.1 Interface Description	3
2.2 Hardware Specifications	4
3. Accessories Installation Steps	6
3.1 3G/4G Installation	6
3.2 SIM Card Installation	6
4. How to play different videos on two screens.....	8
5. Firmware Upgrade Guide.....	8
5.1 Preparation	8
5.2 Upgrade the firmware.....	9
5.2.1. Install the driver in your host PC by following steps	9
5.2.2. Connect the motherboard with host PC	10
5.2.3. Start the firmware updating	11
6. JAHC APP	13
6.1 JAHC APP function	13
6.2 Startup (open) & shutdown (close) time setup	13
7. ADB SOP	15

1. Product Introduction

Giada DN74 adopts RK3399 Dual-core ARM Cortex-A72 and Quad-core ARM Cortex-A53 CPU, Onboard memory and eMMC. With dual HDMI display output, it supports 1*4K and 1*2K resolution. It is featured with Android 7.1 operation system. The player is suitable to be applied in high-end Android digital signage applications.

2. Interface Description and Hardware Specifications

2.1 Interface Description

Front I/O Port

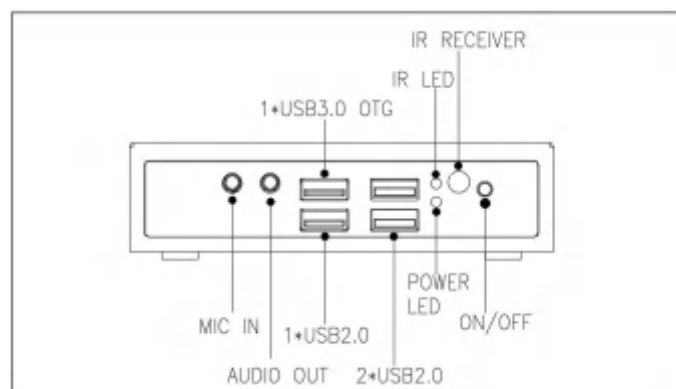

Rear I/O Port

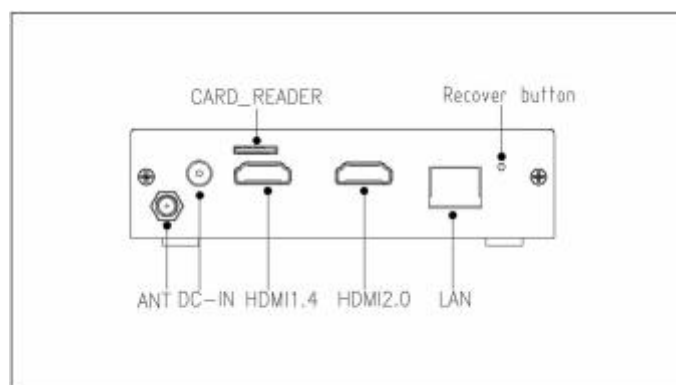

Right I/O port

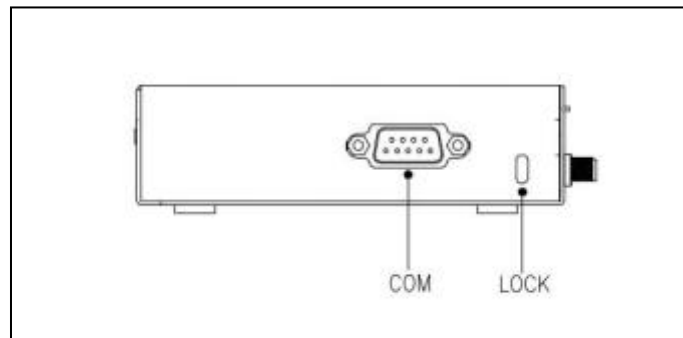

2.2 Hardware Specifications

DN74		DN74-3399R42E5G-GIA V2
Processor	CPU	RK3399 Dual-core ARM Cortex-A72 and Quad-core ARM Cortex-A53 CPU
	Frequency	Up to 1.5GHz
	Chipset	SOC
Memory	Type	LPDDR4 support 2 channels
	Socket	Onboard
	Capacity	4GB (Optional: 2GB)
Graphics	GPU	Mali-T860MP4 GPU
	Graphic Engine	4K H.264/H.265 video decoder
	HDMI	1 x HDMI (Max 4K@60Hz), support CEC 1 x HDMI (Max 2K@30Hz)
Network	Controller	Realtek RTL8211E Gigabit Ethernet
	Interface	1 x RJ45
I/O Interface	USB	1 x USB3.0 (OTG), 3 x USB2.0
	Serial Port	1 x RS232
	Audio	1 x MIC-IN, 1 x AUDIO-OUT
	Mini-PCle	1 x Full-size Mini-PCle for 3G/4G
	WiFi+BT Module	WiFi+BT Module Onboard (WiFi 5GHz) (Optional: 2.4GHz)
	SIM Slot	1 x SIM Slot
	LED Indicator	1 x HDD LED, 1x Power LED
Storage	eMMC	Onboard eMMC 32GB (Optional: 16G)
	TF Card Reader	1 x TF Card Reader

JAHC	JAHC	Watchdog / Auto power on/IR Remote Control / RTC/Wake On Lan
Operation System	OS	Android7.1
Power	Power Type	DC-IN
	Input Voltage	12V/2A
Mechanical	Construction	Metal
	Fanless	Yes
	Mounting	Desk/VESA Mounting (JC530)
	Dimension (W x D x H)	116.6mm x 107.4mm x 30mm
	Color	Black
Environment	Operating Temperature	0-40°C at 0.7m/s Air Flow
	Relative Humidity	95%@40°C (non-condensing)
Certification		CE/FCC

3. Accessories Installation Steps

▲ For safety reasons, please ensure that the power cord is disconnected before opening the case.

How to open bottom cover

Unscrew the four screws and remove the bottom cover. (mini PCIE slot for 3G/4G and SIM card slot are on this side)



3.1 3G/4G Installation

▲ Default SMA connector and cable is for WIFI. Please change to 3G/4G SMA connector and cable.

1. Plug the 3G/4G module into the mini PCIE slot.
2. Secure the module to the carrier by tightening up the screw.
3. Connect the cable to **Main** and install the antenna.



3.2 SIM Card Installation

▲ This product supports standard SIM card with the size of 25mm × 15mm.

1. [Open] the SIM card holder and pull it up.
2. Insert the SIM card.
3. [Lock] the card holder.

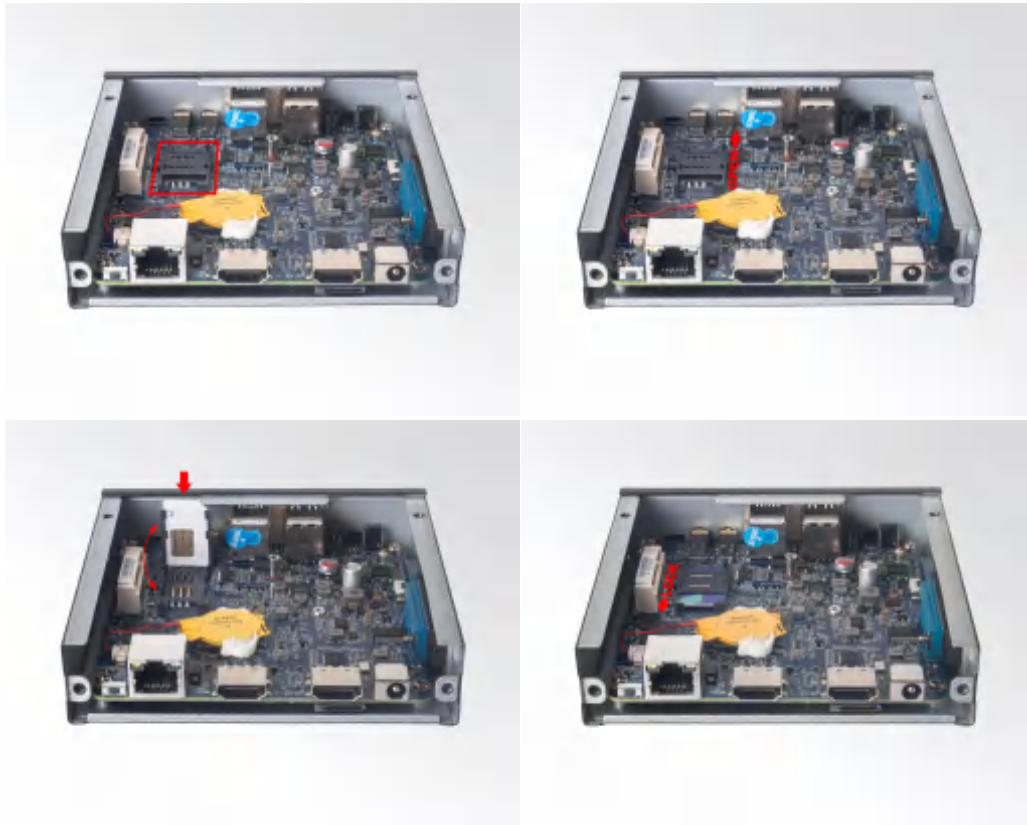

4. How to play different videos on two screens

The two HDMI ports on DN74 support clone mode, but you can play different videos on two screens by following setup:

- a. Install two different video player apps which support 4K decoding in DN74.
- b. Connect DN74 with two HDMI screens, you can see they are clone mode.
- c. Play one video with one of the video player app and press 'Alt+D' to enter into presentation display mode, then the video will show on the second screen.
- d. Back to android home, then play another video by the other video player app. You will see the two screens show different videos.

Note: According to DN74's decoding capabilities, one output can be up to 4K@60FPS and the other one will be 1080P@30FPS at the same.

5. Firmware Upgrade Guide

5.1 Preparation:

- DN74 player
- Archive of DN74 firmware provided by Giada technical support
- Host PC with screen and installed the Windows operation system.
- USB OTG Cable (RP-SMA Male↔RP-SMA Male)



After you get the Archive from Giada technical support, copy the Archive to your host PC, you will find below files inside:

- Android Tool - tool for updating
- DN74 Firmware image.
- DriverAssitant - tool to install drivers and firmware image file



5.2 Upgrade the firmware

5.2.1. Install the driver in your host PC by following steps:

- a. Click the DriverAssitant file. Launch RK DriverAssitant and press “Install Driver”.

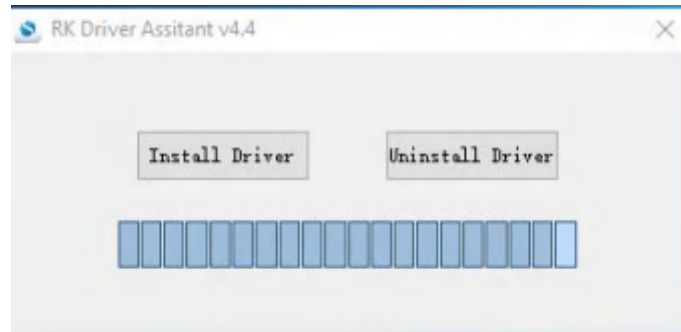

Apply all changes and warnings during the installation.



- b. Click “ok” after the installation finish

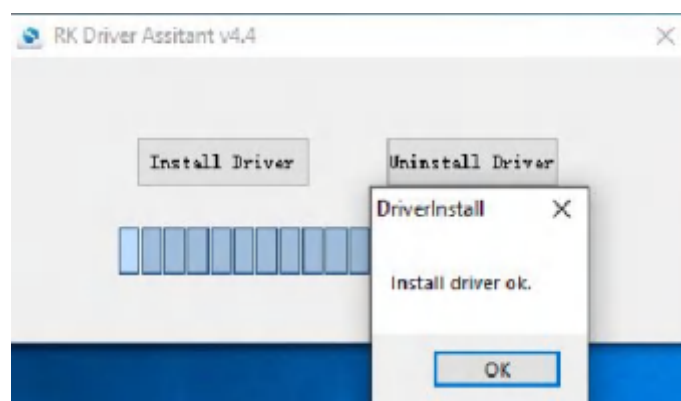

5.2.2. Connect the DN74 with host PC

In order to connect the DN74 with Host PC and run bootloader mode, you should perform following steps:



- Please ensure that the power of the DN74 player is disconnected
- Run Android tool V2.63 under the windows of the host PC.
- Connect the DN74 player to the host PC via usb OTG port (please refer to Fig1 for location of the OTG port)
- Firstly, hold the DN74 player recovery button (please refer to Fig1 for the location of the button), then connect the power adaptor to the player, you will see “Found a MSC Device” or “Found One Loader Device”. (Please refer to Fig2)

⚠ Please don't loosen the button and don't press twice until you see the 'Found a MSC Device' or 'Found One loader device'



(Fig1)

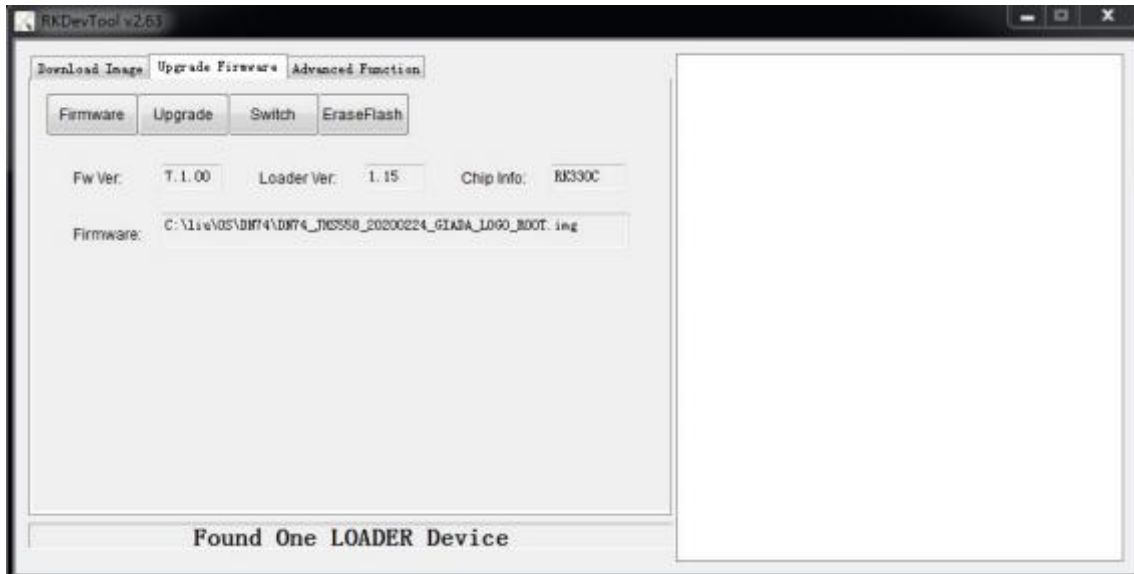

(Fig2)

5.2.3. Start the firmware updating.

- Click "Firmware" button and specify the path to the firmware file which is stored in the host PC (Please refer to Fig2).
- Wait around 5 seconds to upload the program, FW information will be displayed on the screen. After the "Upgrade" button turns to black, you can click "Upgrade" to update the firmware (please refer to Fig3 and Fig4).

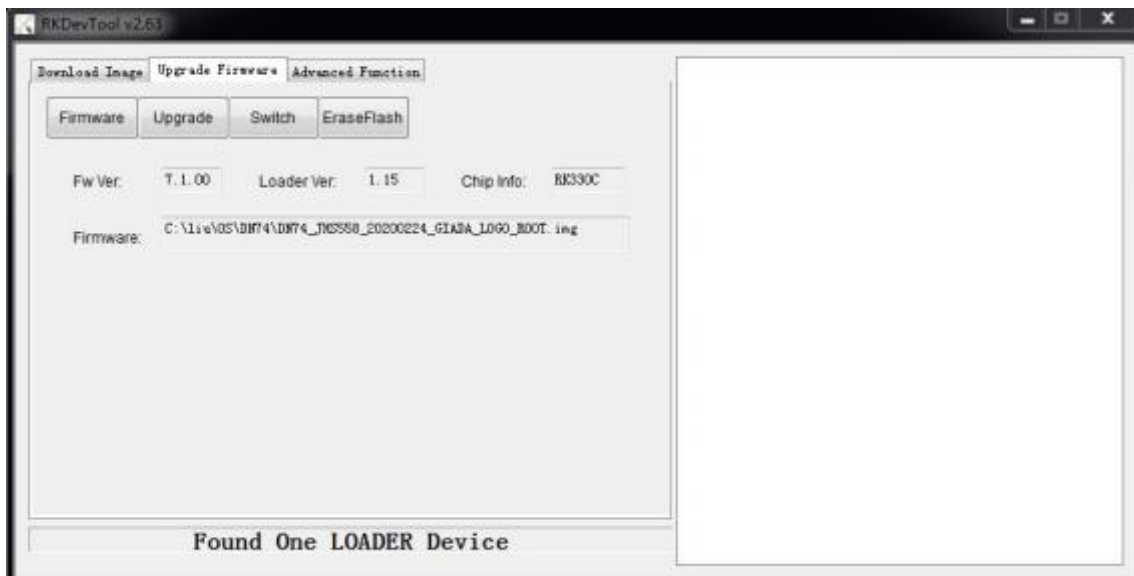

(Fig3)

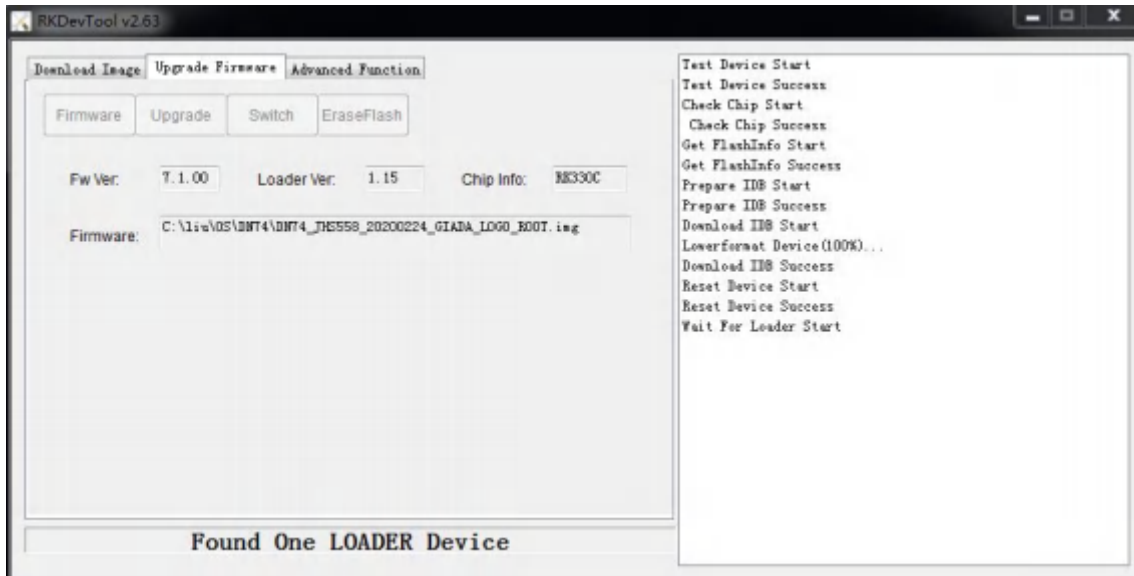

(Fig4)

c. In the end, you will see a report indicating a successful operation.

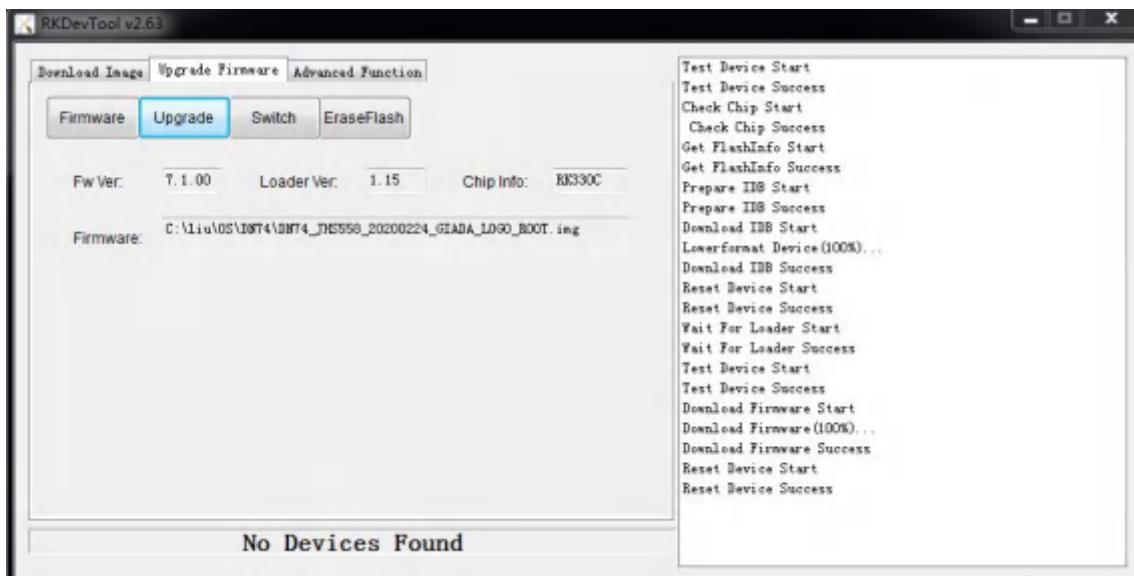

6. JAHC APP

6.1 JAHC APP functions

The user can set up automatic startup and shutdown, one week as a circle

6.2 Startup (open) & shutdown (close) time setup

System Requirements:

- Giada player with JAHC APP function.
- Android OS includes JAHC APP (please refer to Fig1) .

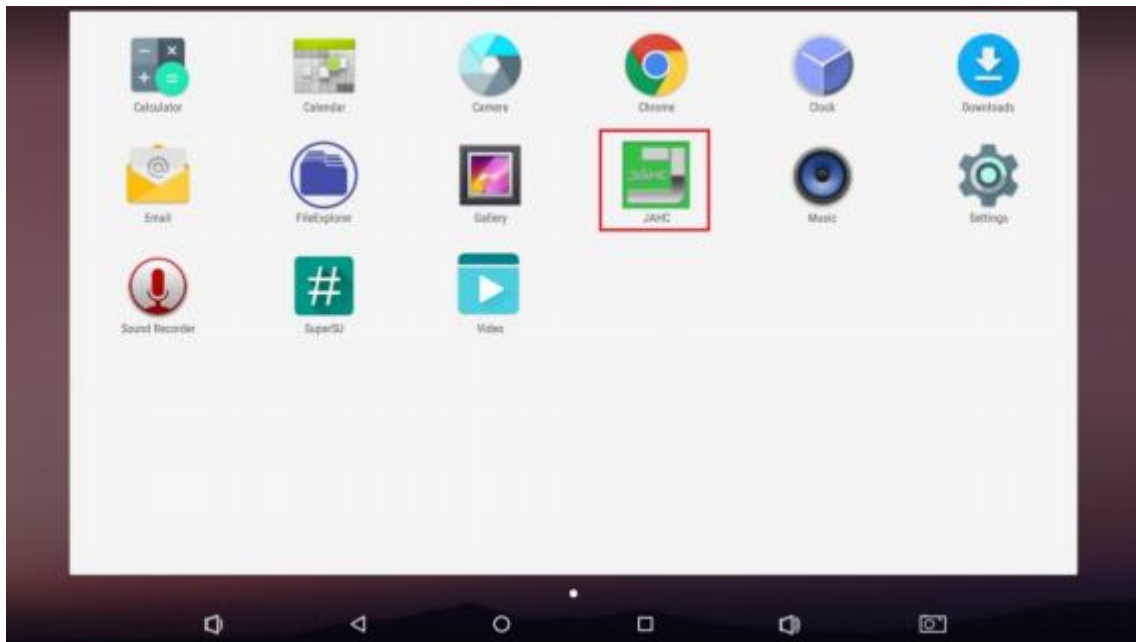

(Fig1)

a. After enter the android desktop, click the JAHC APP icon and the JAHC interface will pop up (please refer to Fig2)

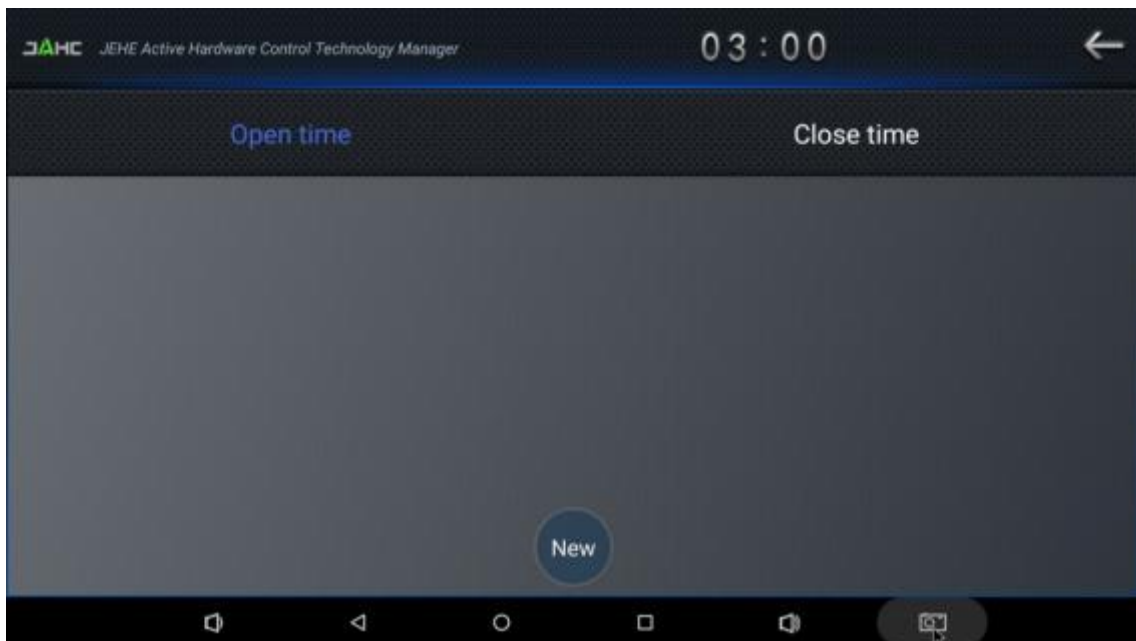

(Fig2)

- b. Click 'New' button to set open time (Fig3) and then click Close time button to set close time. One week as a circle, maximum 3 schedules per day. Select each schedule to set up the Open time and Close time.
- c. After finishing the setup, click circles to launch the schedule. User can click delete to remove the schedule.

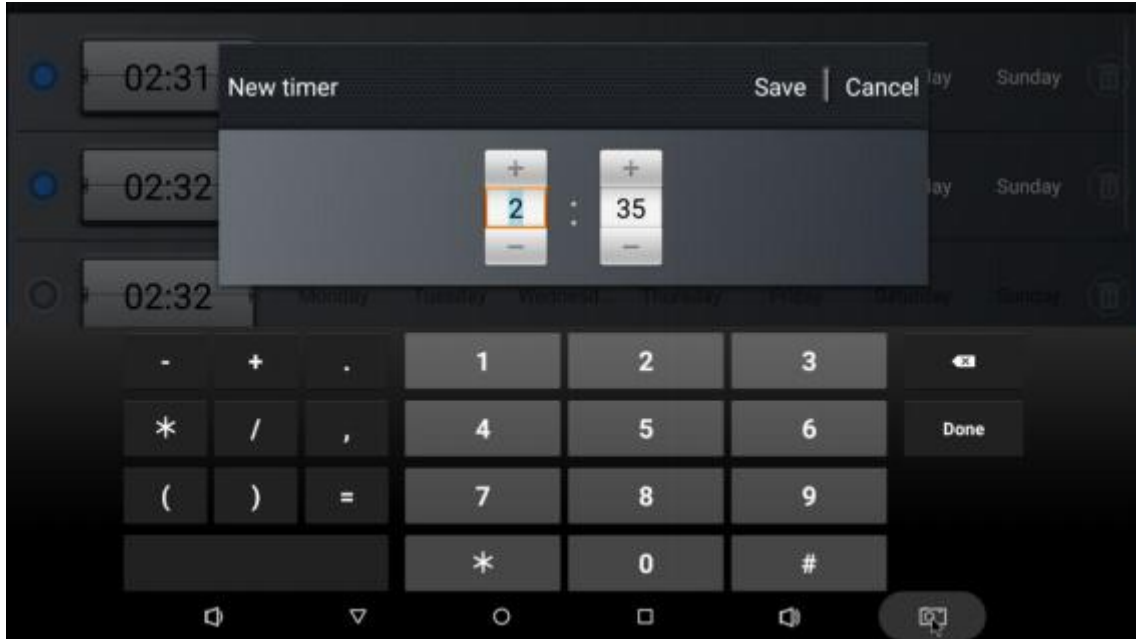

(Fig3)

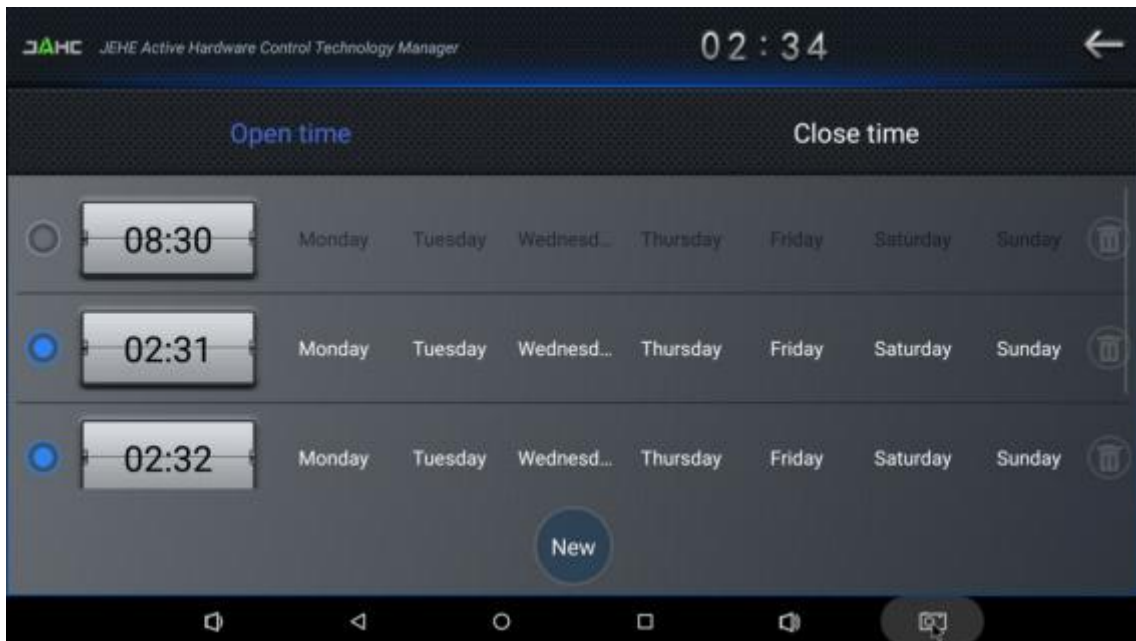

(Fig4)

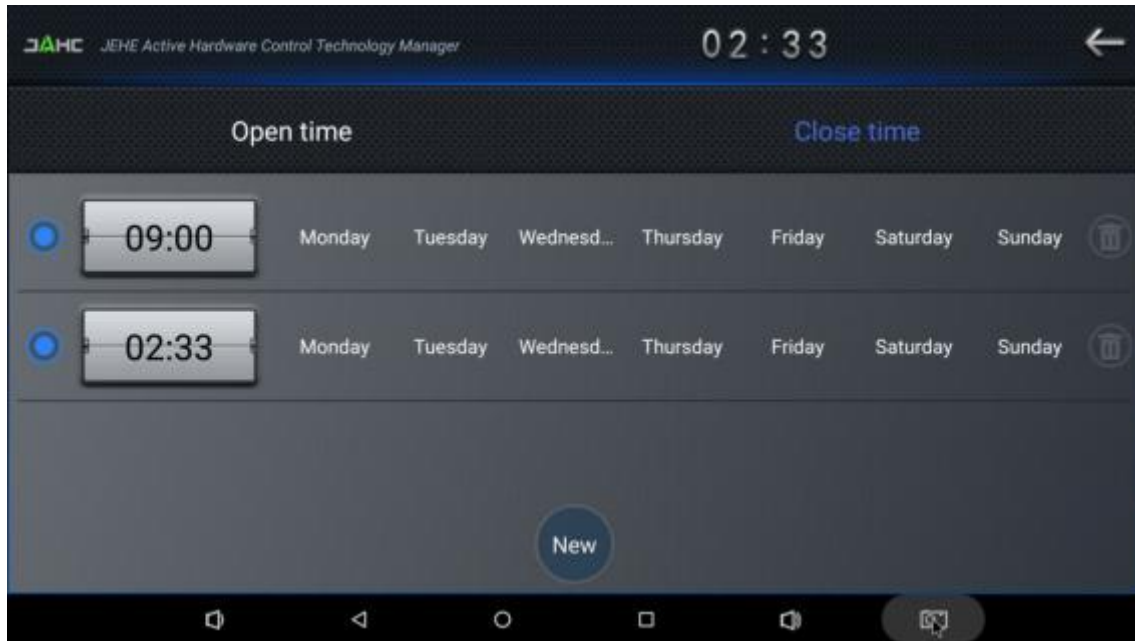

(Fig5)

⚠ Caution: If the interval from shutdown time to next resume time is less than 3 minutes, the system will not shut down.

7. ADB SOP

The user can debug APP with ADB driver by below steps:

a. Use command ADB version to check if Windows ADB tool is installed.

```
C:\> Admin: C:\Windows\system32\cmd.exe
C:\Users>adb version
Android Debug Bridge version 1.0.31
C:\Users>
```

b. Install Rock chip driver.

- Connect DN74 with windows PC host by OTG cable.
- Select 'Connect to PC' under android OS->Settings->USB->connect to PC.
- Then you can use ADB shell command to enter ADB.

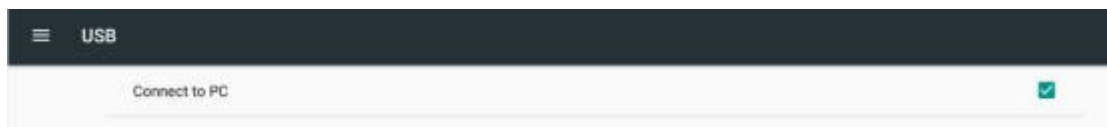

Admin: C:\Windows\system32\cmd.exe - adb shell

```
C:\Users>adb shell  
rk3399_all:/ $
```



Shenzhen JEHE Technology Development Co., Ltd.

Website: www.giadatech.com

Phone: +86-755-33300336

Email: support@giadatech.com

Address: 1~3/F, Block A, Tsinghua Information Harbor, North Section,
Shenzhen Hi-tech Park, Nanshan District, Shenzhen, China



The terms HDMI, HDMI High-Definition Multimedia Interface, and the HDMI Logo are trademarks or registered trademarks of HDMI Licensing Administrator, Inc.